

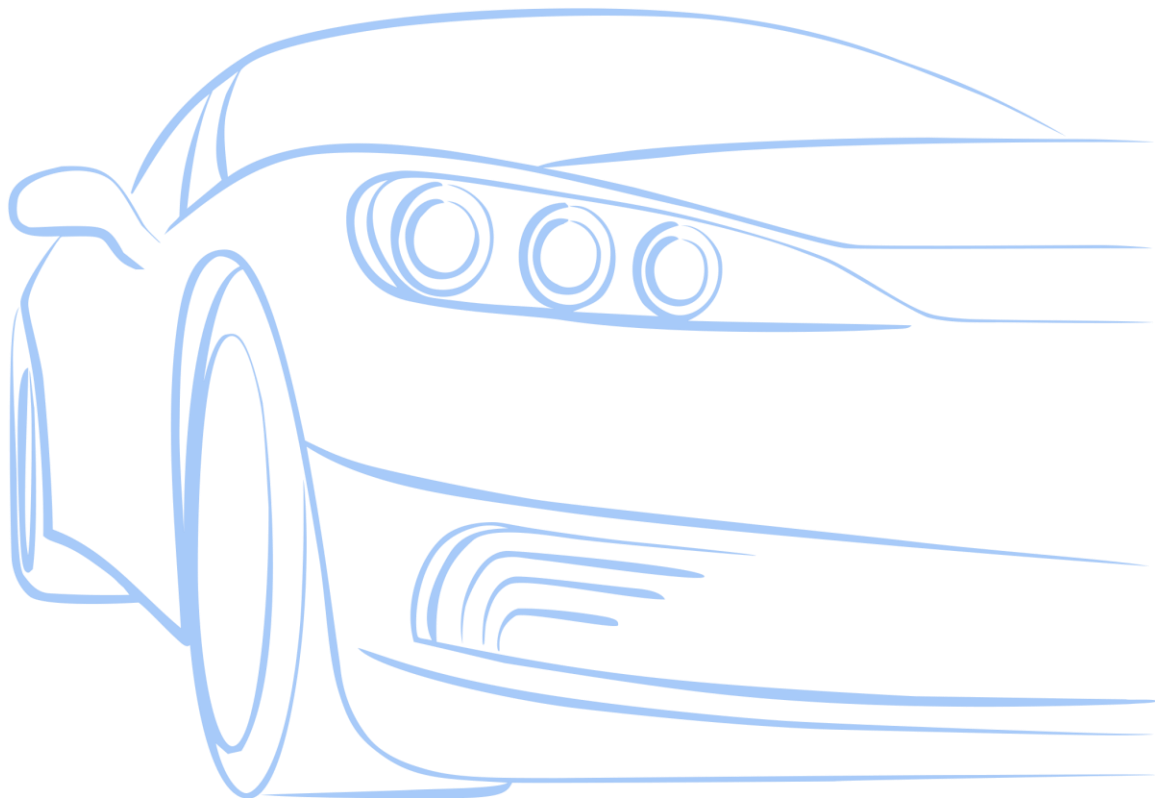

广东晶科电子股份有限公司
APT Electronics Co., Ltd.



Automotive Lighting



EMC 3735 LED Series



Data Sheet



0.5W Dual Color

AE1-CW

Created Date: 2024-03-08 Version 1.0

APT Electronics Co., Ltd.

ADD: No. 33 South of Huanshi Road, Nansha District, Guangzhou
Tel: 020-34684299 Fax: 020-34684977
<http://www.apthk.com>

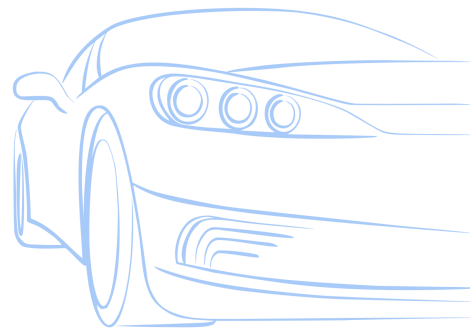

Features (特性)

- Dual Color EMC 3735 Package
(双色 EMC 3735 封装)
- Chip technology: Face-up chip
(正装芯片)
- View angle at 50% Iv of 120°
(发光角度 120°)
- Corrosion Robustness Excellent corrosion robustness
(防腐性能: 优异的防腐能力)
- AEC-Q102 Qualified
(通过 AEC-Q102 认证)
- Suitable for SMT process
(适用于 SMT 组装)
- Available on tape and reel
(适用于载带及卷轴)

Applications (应用)

- Auto Signaling
(汽车信号灯)
- Auto Lighting Interior and Exterior
(车内外照明)
- Signal and Symbol Luminary
(信号与标志灯具)

Product Nomenclature (产品命名)

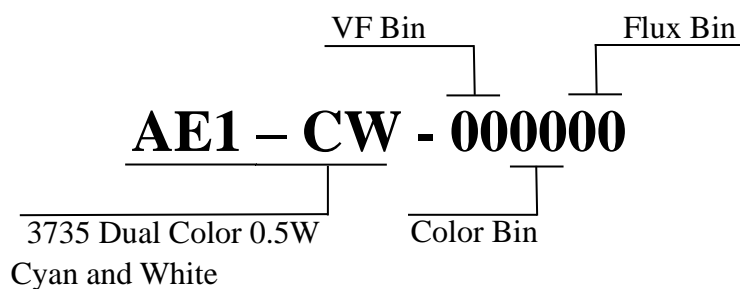

Ordering Information (订购信息)

Type 型号	Luminous Intensity 光通量				Unit 单位
	Color	Min.	Typ.	Max.	
AE1-CW-000000	Cyan	38	42	46	lm
	White	46	52	60	lm

Maximum Ratings (最大额定参数) $T_s=25^\circ\text{C}$, RH60%

Parameter 参数	Symbol 符号	Values 参数值	Unit 单位
Operating Temperature 操作温度	T_{op}	-40~+125	$^\circ\text{C}$
Storage Temperature 储存温度	T_{stg}	-40~+125	$^\circ\text{C}$
Junction Temperature 结温	T_j	150	$^\circ\text{C}$
Forward Current ($T_s=25^\circ\text{C}$) 正向电流	I_F	5~200	mA
Surge Current ($t \leq 100\mu\text{s}$; $D=0.03$; $T_s=55^\circ\text{C}$) 正向脉冲电流	I_{FS}	300	mA
Reverse Voltage 反向电压	Not for Reverse Bias		V
Electrostatic Discharge (acc.to ANSI/ESDA/JEDEC JS-001-2017) 防静电	V_{ESD}	≥ 8	kV

Optical & Electrical Characteristics (光电特性) $I_F=140\text{mA}$, $T_s=25^\circ\text{C}$, RH60%

Item 参数	Symbol 符号	Color 颜色	Min. 最小	Typ. 平均	Max. 最大	Unit 单位
Chromaticity coordinates (CIE 1931 色坐标)	CIE-x,y	Cyan	(0.16, 0.38)			/
		White	(0.322, 0.322)			/
Viewing Angle 发光角度	$2\theta_{1/2}$	Cyan/White	/	120	/	Deg
Forward Voltage 正向电压	V_F	Cyan/White	2.7	3.0	3.3	V
Efficiency 发光效率	LPW	Cyan	/	100	/	lm/W _{el}
		White	/	124	/	
Thermal Resistance junction/solder point 热阻(结点至焊点)	$R_{th(j-sp)real}$	Cyan	/	24	32	K/W
		White	/	24	32	K/W
Electrical Thermal Resistance junction/solder point with efficiency 电热阻(结点至焊点)	$R_{th(j-sp)elec.}$	Cyan	/	18	24	K/W
		White	/	15	20	K/W



Forward Voltage Rank (正向电压分档)

Group Bin Code 组合代码	White Bin Code 白光分档代码	Forward Voltage/V 正向电压/V	PC-Amber Bin Code 黄光分档代码	Forward Voltage/V 正向电压/V
1V	VK	2.7-3.0	VK	2.7-3.0
2V	VK	2.7-3.0	VL	3.0-3.3
3V	VL	3.0-3.3	VL	3.0-3.3
4V	VL	3.0-3.3	VK	2.7-3.0

- Tolerance of measurements of the Forward voltage is $\pm 0.05V$ (正向电压的测试误差 $\pm 0.05V$)
- $I_F=140mA$, $T_s=25^\circ C$, $RH60\%$ (电流: 140mA, 温度: 25 $^\circ C$, 湿度: 60%)
- Group Bin Code on label (标签显示组合代码)

Chromaticity Region & Coordinate (色域/色坐标)

Cyan Color

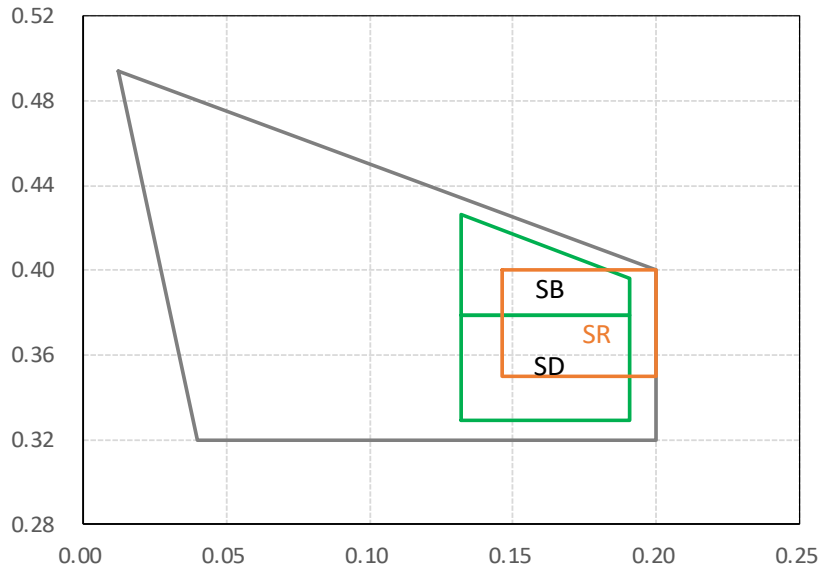

SC		SD		SR	
Cx	Cy	Cx	Cy	Cx	Cy
0.083	0.329	0.132	0.329	0.146	0.400
0.075	0.379	0.132	0.379	0.200	0.400
0.132	0.379	0.191	0.379	0.200	0.350
0.132	0.329	0.191	0.329	0.146	0.350



White Color

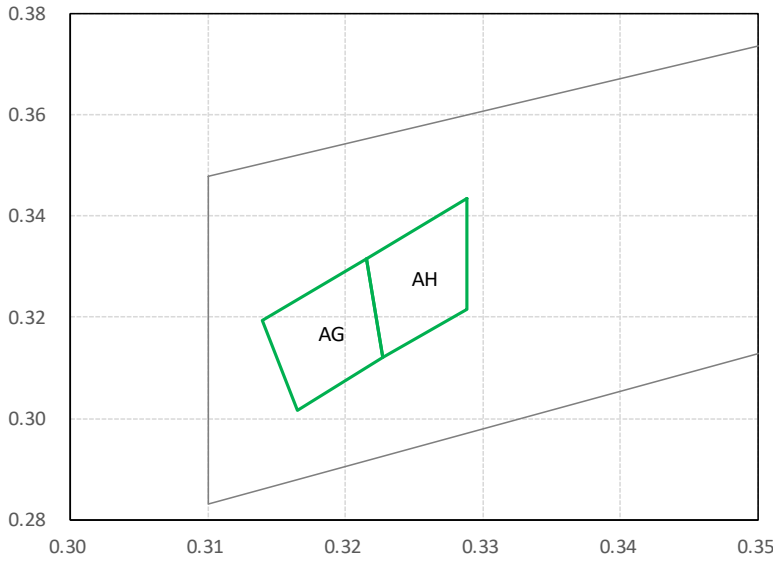

AG(6000-6500K)		AH(5600-6000K)	
Cx	Cy	Cx	Cy
0.3215	0.3315	0.3288	0.3435
0.3227	0.3120	0.3288	0.3215
0.3165	0.3015	0.3227	0.3120
0.3140	0.3195	0.3215	0.3315

- Tolerance of measurements of the Cx,Cy is ± 0.003 (Cx,Cy 的测试误差 ± 0.003)
- $I_F=140\text{mA}$, $T_S=25^\circ\text{C}$, $RH60\%$ (电流: 140mA, 温度: 25°C, 湿度: 60%)

Group Bin Code 组合代码	Cyan Bin Code 青光分档代码	White Bin Code 白光分档代码
C1	SC	AG
C2	SC	AH
C3	SD	AG
C4	SD	AH
C5	SR	AG
C6	SR	AH

- Group Bin Code on label (标签显示组合代码)

Luminous Flux Rank (光通量分档)

Group Bin Code 组合代码	Cyan Bin Code 青光分档代码	Flux (lm) 光通量/lm	White Bin Code 白光分档代码	Flux (lm) 光通量/lm
3J	C5	38-42	C7	46-50
3K	C5	38-42	D1	50-60
4K	C6	42-46	C7	46-50
4L	C6	42-46	D1	50-60

- Tolerance of measurements of the Luminous Flux is $\pm 5\%$ (光通量的测量误差 $\pm 5\%$)
- $I_F=140\text{mA}$, $T_S=25^\circ\text{C}$, $RH60\%$ (电流: 140mA, 温度: 25°C, 湿度: 60%)
- Group Bin Code on label (标签显示组合代码)



Optical & Electrical Characteristics Curves (光电特性曲线)

$I_F=140\text{mA}$, $T_S=25^\circ\text{C}$, $\text{RH}60\%$

Fig.1 Relative Spectral Emission (相对光谱)

$$I_{\text{rel}} = f(\lambda)$$

Cyan

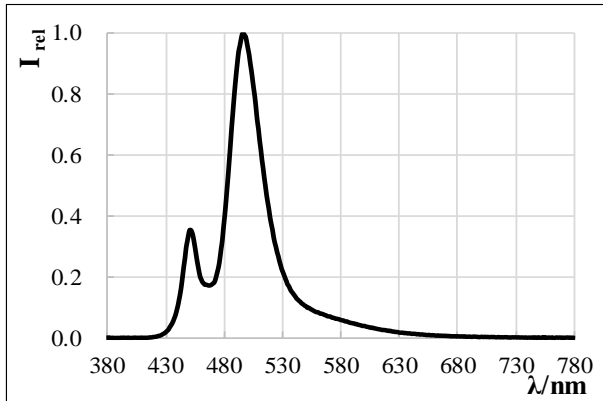

White

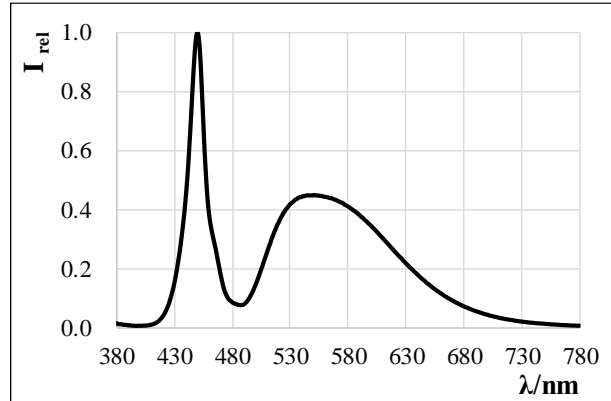
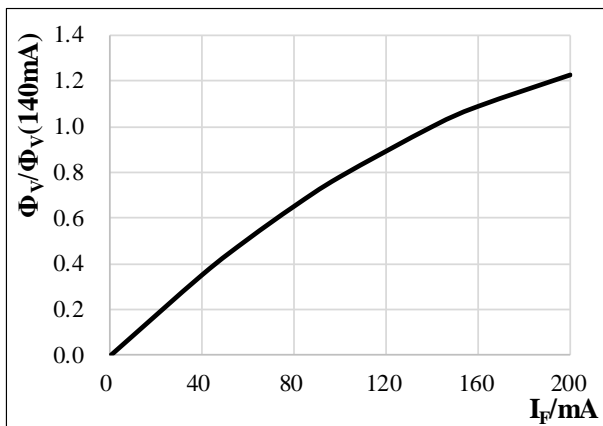

Fig.2 Forward Current Vs. Relative Intensity (相对亮度与电流关系)

$$\Phi_V/\Phi_V(140\text{mA}) = f(I_F)$$

Cyan



White

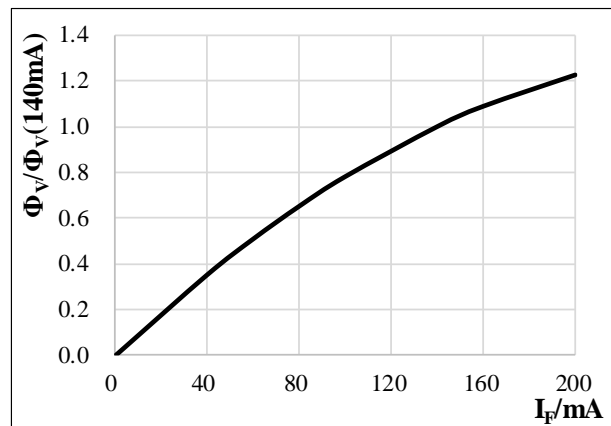

Fig.3 Forward Voltage Vs. Forward Current (电流与电压关系)

$$I_F = f(V_F)$$

Cyan & White

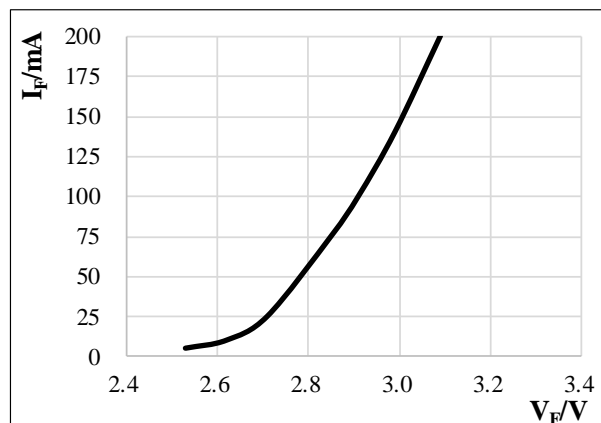
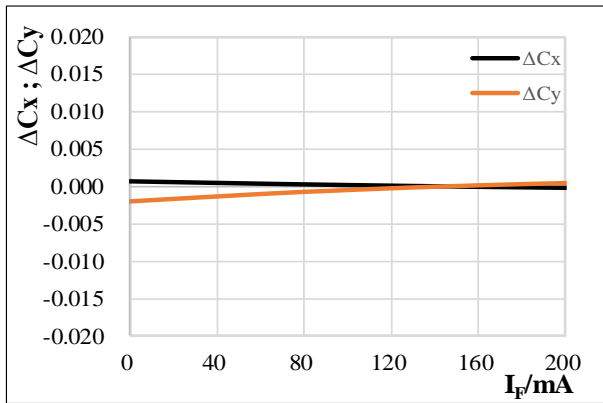



Fig 4. I_F Vs. Chromaticity Coordinate (正向电流与相对色度坐标关系)

$\Delta C_x, \Delta C_y = f(I_F)$

Cyan



White

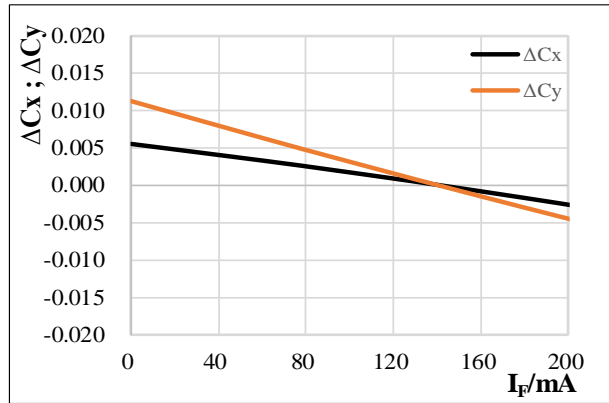
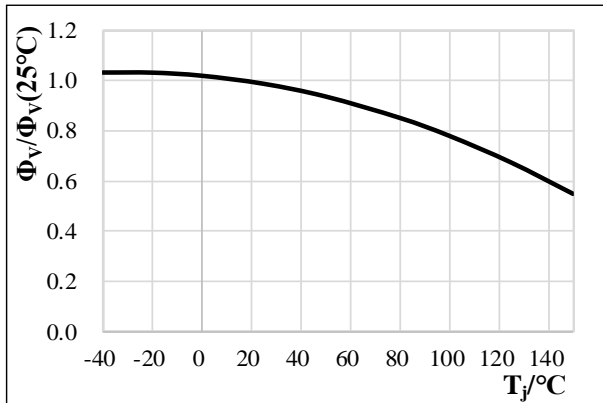

Fig 5. Junction Temperature Vs. Relative Intensity (结温与相对亮度关系)

$\Phi_V / \Phi_V(25^\circ C) = f(T_j)$

Cyan



White

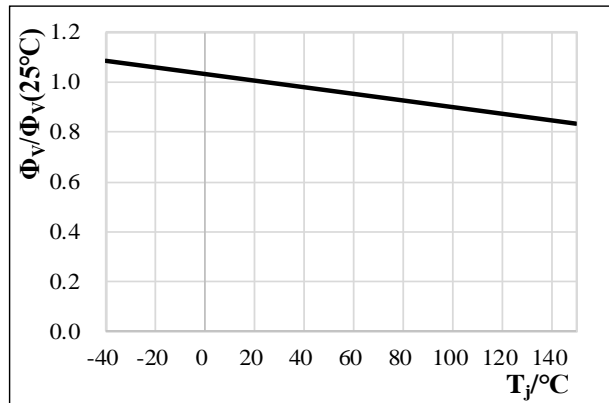

Fig 6. Junction Temperature Vs. ΔV_F (结温与相对电压关系)

$\Delta V_F = V_F - V_F(25^\circ C) = f(T_j)$

Cyan & White

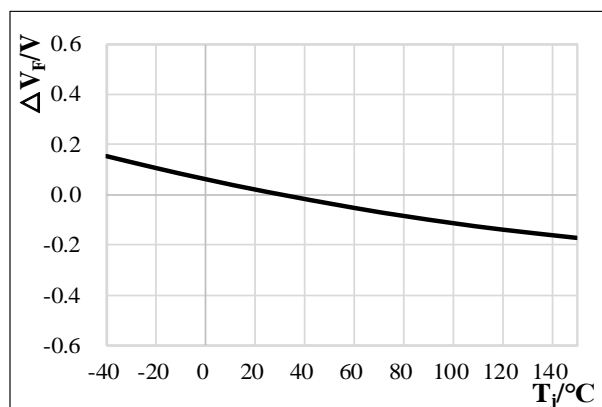
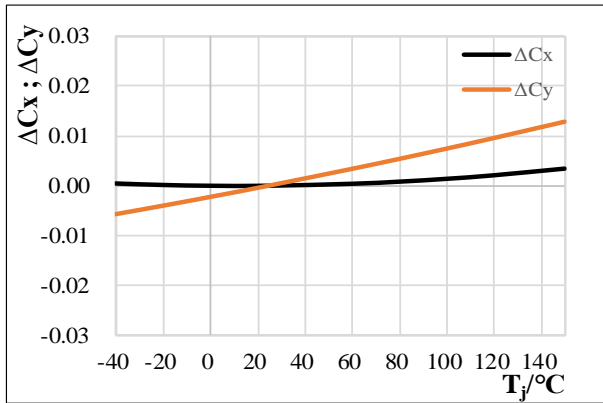



Fig 7. Junction Temperature Vs. Chromaticity Coordinate (结温与相对色度坐标关系)

$\Delta C_x, \Delta C_y = f(T_j)$

Cyan



White

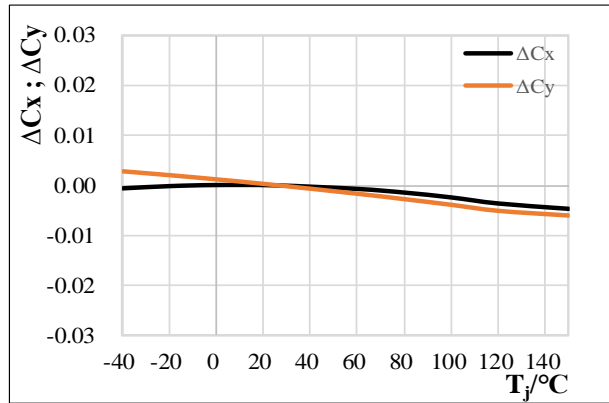

Fig 8. T_s Vs. Max. Permissible I_F (温度与最大允许电流关系)

$I_F = f(T_s)$

Cyan & White

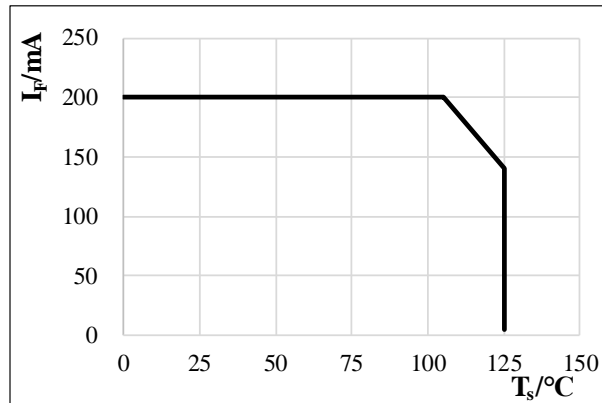
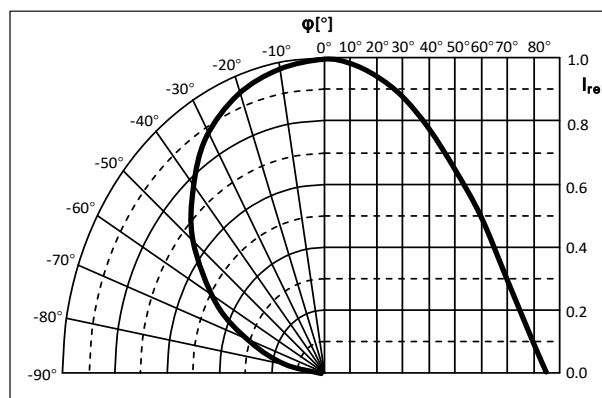

Fig 9. Radiation diagram (辐射图特性曲线)

$I_{rel} = f(\Phi)$

Cyan & White





Reflow Soldering Characteristics (建议回流焊方式)

Product complies to MSL Level 2 acc. To JEDEC J-STD-020 D.01

产品符合 MSL 2 级水平 (JEDEC J-STD-020 D.01 标准)

Reflow soldering 回流焊	
Temperature Min (T _{smin})	150° C
Temperature Max (T _{smax})	200° C
Time(ts)from (T _{smin} to T _{smax})	60-120 seconds.
Ramp-up rate (TL to T _p)	3° C/seconds max.
Liquidous temperature(TL)	217° C
Time(ts) maintained above TL	60-150 seconds
Peak package body temperature(T _p)	260° C max
Time (t _p) within 5° C of the specified classification temperature(T _c).	30 seconds max
Ramp-down rate (T _p to TL)	6° C/second max
Time 25° C to peak temperature	8 min max

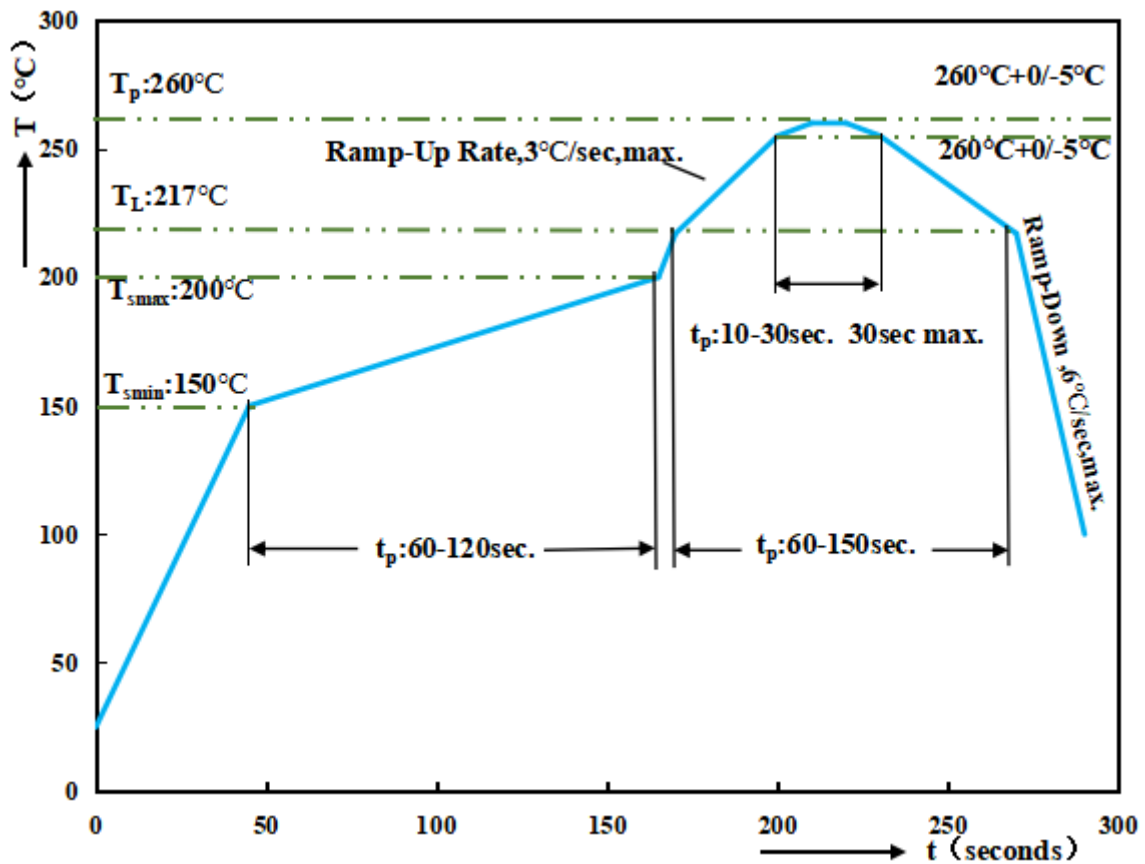

Mechanical Dimensions (机械尺寸)

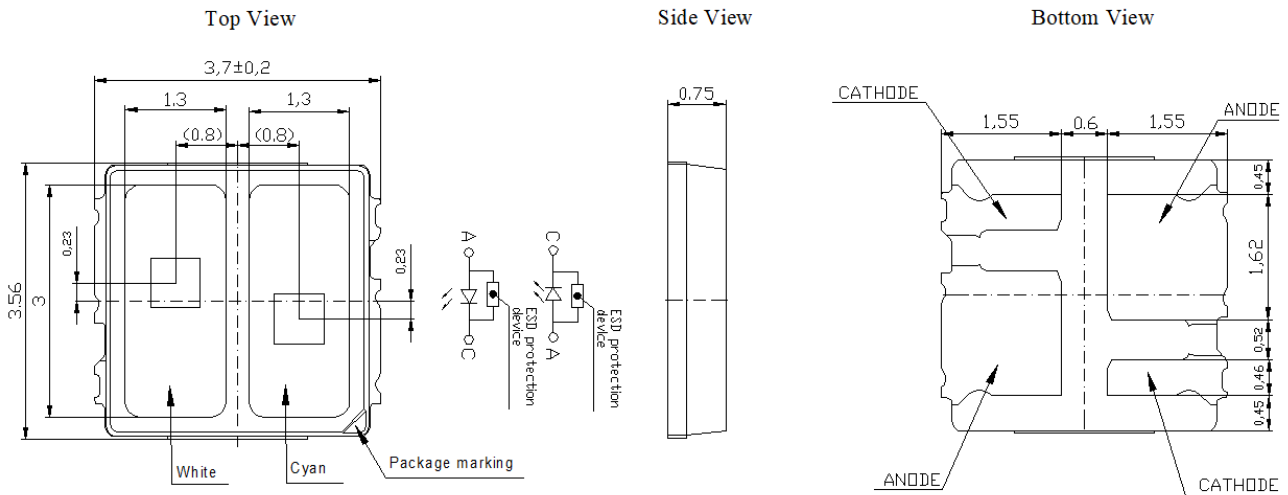

DABE1007

- All dimensions are in millimeters (图中所有尺寸均以毫米为单位)
- Tolerance is $\pm 0.1\text{mm}$, unless otherwise noted (尺寸公差 $\pm 0.1\text{mm}$,除特殊标注外)
- Approximate weight: 50.0mg (大致重量: 50.0mg)

Recommended Solder Pad (焊盘设计)

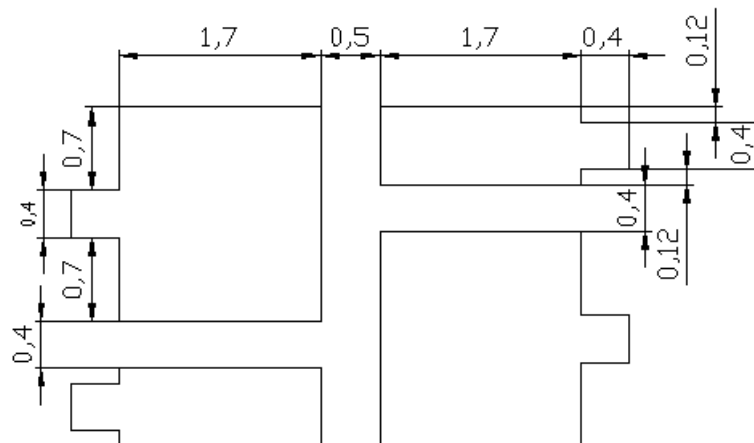

DACE1007

- All dimensions are in millimeters (图中所有尺寸均以毫米为单位)
- Tolerance is $\pm 0.1\text{mm}$, unless otherwise noted (尺寸公差 $\pm 0.1\text{mm}$,除特殊标注外)
- The drawings are for reference only. (图纸仅供参考)

Packaging Information (封装信息)

(1) Label (标签)

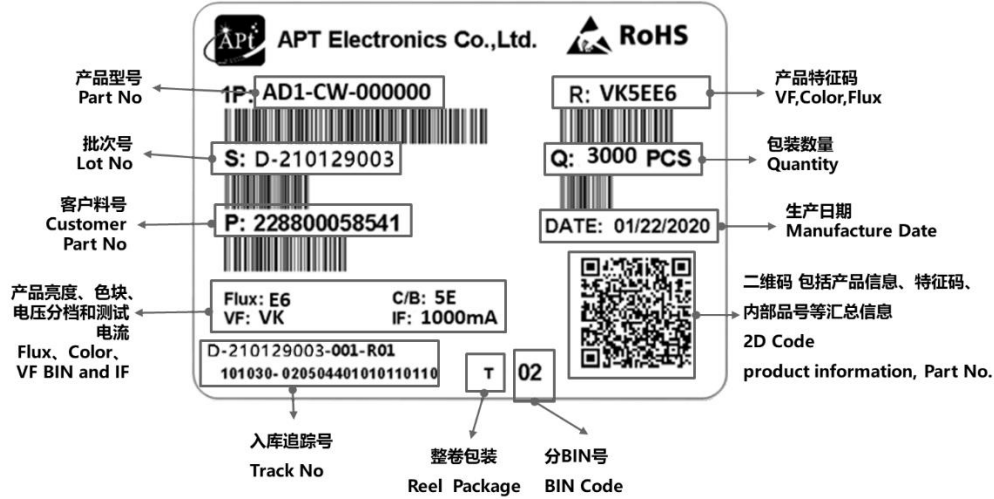

(2) Tape spec (卷带) Unit: mm (单位:mm)

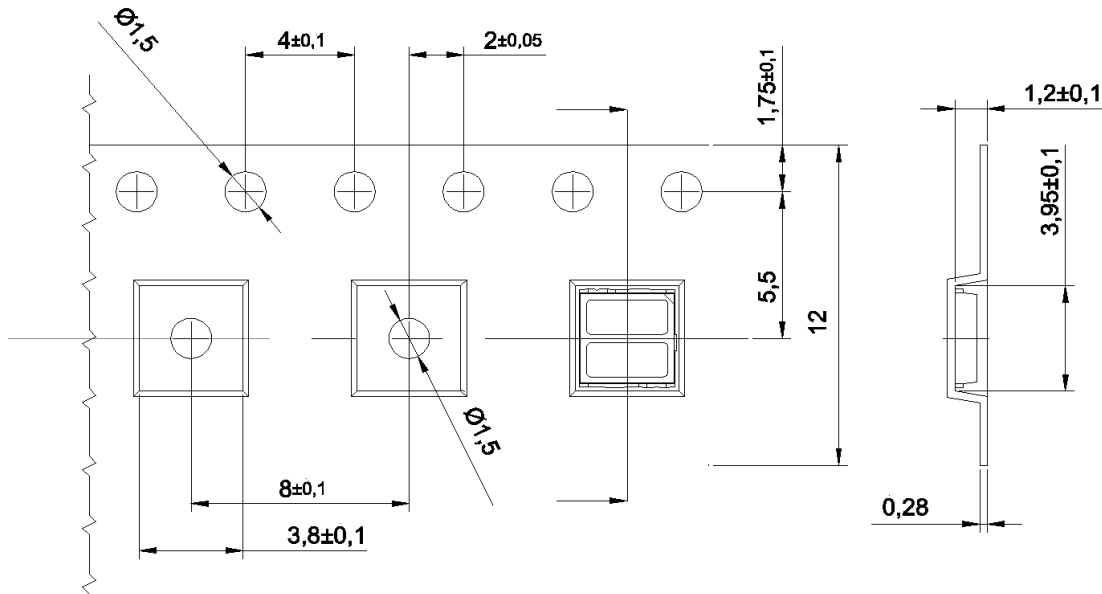

- Quantity : 3000pcs/Reel
数量: 3000pcs/卷
- Cumulative Tolerance : Cumulative Tolerance/10 pitches to be ± 0.2 mm
累计误差: 每10个凹槽的累计误差为 ± 0.2 mm
- Adhesion Strength of Cover Tape Adhesion strength to be 0.1-0.7N when the cover tape is turned off from the carrier tape at the angle of 10° to the carrier tape.
以 10° 的角度将盖带从载带上剥离, 两者间的粘接力为0.1~0.7N。
- Package : P/N, Manufacturing data Code No. and Quantity to be indicated on a damp proof Package.
包装信息: 包含部件号码, 制造日期代码以及防潮标记。

(3) Reel Dimensions (卷盘尺寸)

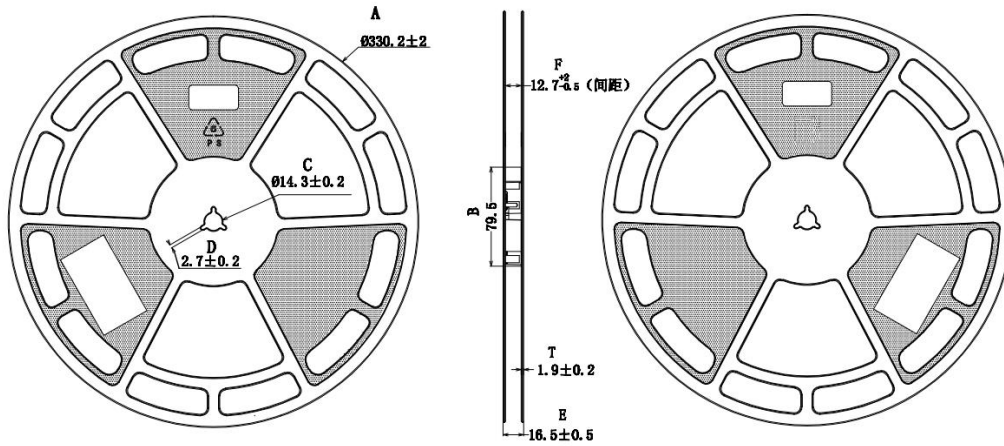

(4) Moisture Resistant Package (防潮袋包装)

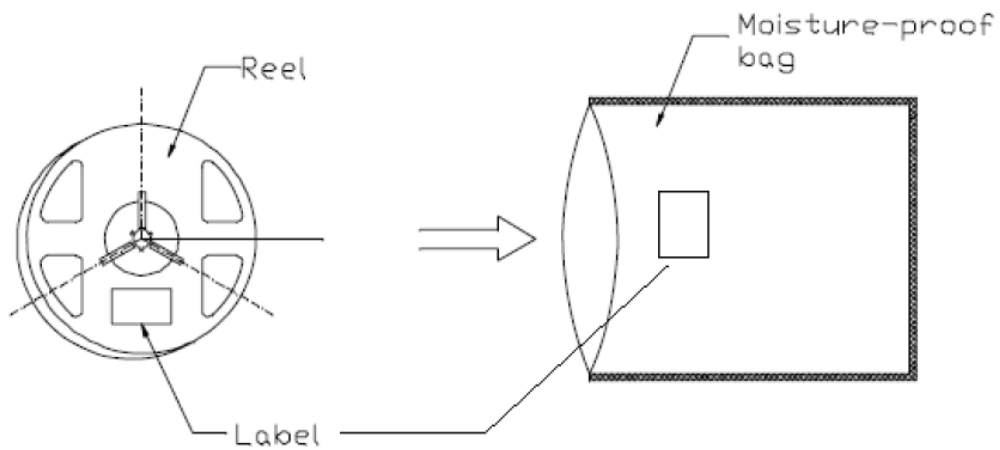

(5) Package Box (包装箱)

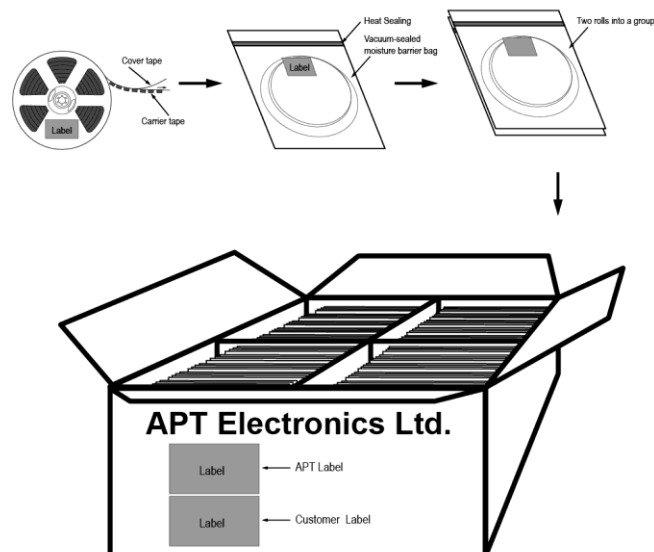



Application Notes (使用指引)

1) Storage 正常储存

To avoid the moisture penetration, we recommend store in a dry box with a desiccant, The maximum storage temperature range is 40°C and a maximum humidity of RH60%.

为避免湿度侵入影响, 建议储存有干燥剂的干燥柜, 最大储存温度和最大湿度为 40°C, 相对湿度 60%。

2) Use Precaution after Opening the Packaging 开封后使用注意事项

Recommend conditions after opening the package 开封后推荐密封和储存条件

-Sealing 密封

-Temperature : 30°C Humidity : Less than RH50% 储存温度 30°C, 相对湿度小于 50%。

-Recommend to use up before 72hrs after opening the package. 推荐开封后 72 小时内使用完成。

3) If the package has been opened more than 4 weeks(MSL_2) or the color desiccant changes, LED Components should be dried for 12hrs at 60±5°C. 如果包装开封后超过 4 周或干燥剂发生变化, LED 器件需要在 60°C 下干燥除湿 12 小时。

4) Do not apply mechanical force or excess vibration during the cooling process to normal temperature after soldering. 在焊接后冷却至常温的过程中, 不要使用机械力和额外的震动。

5) Do not rapidly cool device after soldering. 不要在焊接后快速冷却。

6) The LED should not be mounted on warped portion of PCB. LED 不建议贴装于弯曲的 PCB 上。

7) The LED should not be used in any type of fluid such as water, oil, organic solvent and etc. When washing is required, IPA (Isopropyl Alcohol) should be used. 器件不要接触水、油及有机溶剂等液体, 如需清洗, 可以使用异丙醇。

8) When the LEDs are in operation the maximum current should be decided after measuring the package temperature. LED 在最大使用电流下, 应当测试封装体的温度。

9) Long time exposure of sunlight or occasional UV exposure will cause lens discoloration. 长时间暴露在阳光或 UV 光下会导致光学材料的变色。

10) The driving circuit must be designed to allow forward voltage only when it is ON or OFF. If the reverse voltage is applied to LED, migration can be generated resulting in LED damage. LED 驱动必须属于正向以开或关的形式驱动, 如果加载反向电压, 会导致 LED 损坏。

11) LEDs are sensitive to Electro-Static Discharge (ESD). Below is a list of suggestions that APT purposes to minimize these effects. LED 属于静电敏感元件, 下列为使用过程中需要静电防护注意事项。

The products are sensitive to static electricity or surge voltage. ESD can damage a die and it's Reliability. When handing the products, the following measures against electrostatic discharge are strongly recommended:

LED 产品属于静电和高压敏感元件, ESD 会导致 LED 芯片损坏影响可靠性, 在处理产品时, 强烈建议下列情况出现防静电措施:

-Increase in reverse leakage current lowered turn-on voltage 反向漏电流增加以降低开启电压。

-Abnormal emissions from the LED at low current LED 在小电流下的发光异常。

The following recommendations are suggested to help minimize the potential for an ESD event. One or more recommended work area suggestions: 下列措施有助于降低 ESD 的潜在失效

-Dissipating static charge with conductive materials 使用导电材料导通静电

-Preventing charge generation with moisture 防止湿度产生静电

-ESD safe storage containers ESD 防护储存容器

One or more personnel suggestion options: 个人防护建议

-Antistatic wrist-strap 戴防静电手环

-Antistatic material shoes 穿防静电鞋

-Antistatic clothes 穿防静电服

Environmental controls: 环境要求

-Humidity control (ESD gets worse in a dry environment) 湿度控制



12) Handling Precautions 操作注意事项

During processing, mechanical stress on the surface should be minimized as much as possible. Sharp objects of all types should not be used to pierce the sealing compound. 使用过程中，避免机械外力和尖锐的物体作用于 LED 表面。

In general, LEDs should only be handled from the side. By the way, this also applies to LEDs Without a silicone sealant, since the surface can also become scratched. 一般来说，LED 操作应在侧面。

APT suggests using isopropyl alcohol for cleaning. In case other solvents are used, it must be assured that these solvents do not dissolve the package or resin. 推荐使用 IPA 清洁，如果需要使用溶剂，必须保证溶剂不能溶解封装体或硅胶。

Please do not mold this products into another resin (epoxy, urethane, etc.) and do not handle this Product with acid or sulfur material in sealed space. 不建议把封装体放入其他树脂中如环氧，丙烯等，不建议在有酸性和含硫材料的环境下使用。

Notes (说明)

The evaluation of eye safety occurs according to the standard IEC 62471:2006 (photo biological safety of lamps and lamp systems). Within the risk grouping system of this IEC standard, the device specified in this data sheet falls into the class exempt group (exposure time 10000 s). Under real circumstances (for exposure time, conditions of the eye pupils, observation distance), it is assumed that no endangerment to the eye exists from these devices. As a matter of principle, however, it should be mentioned that intense light sources have a high secondary exposure potential due to their blinding effect. When looking at bright light sources (e.g. headlights), temporary reduction in visual acuity and afterimages can occur, leading to irritation, annoyance, visual impairment, and even accidents, depending on the situation.

人眼安全的评估按照 IEC 62471:2006 标准(photo biological safety of lamps and lamp systems) 进行。在本 CIE 标准的风险分组系统中，本数据表中指定的 LED 属于该类 豁免等级 (暴露时间 10000 s)。在某些情况下(如不同的暴露时间、瞳孔大小、观察距离等)，尽管这些产品对人眼没有危害。但从理论上来说，由于强光光源的致盲作用，它们具有很高的二次曝光可能性。例如当注视其他明亮的光源(如前照灯)时，也会出现视力暂时下降和余影情况，也可能导致不同程度的急躁、恼怒、视力受损等情形。

Subcomponents of this device contain, in addition to other substances, metal filled materials including silver. Metal filled materials can be affected by environments that contain traces of aggressive substances. Therefore, we recommend that customers minimize device exposure to aggressive substances during storage, production, and use. Devices that showed visible discoloration when tested using the described tests above did show no performance deviations within failure limits during the stated test duration. Respective failure limits are described in the IEC60810.

除其他物质外，该器件的子组件还包含金属填充材料，包括银。金属填充材料可能会受到含残留侵蚀性物质的环境的影响。因此，我们建议客户在存储、生产和使用过程中尽量少将器件暴露于腐蚀性物质环境中。当使用上述测试条件进行测试时，器件在规定的测试持续时间内表现出了颜色的变化，但其各项性能的变化均未超出失效极限的定义。IEC60810 中描述了相关的各项失效极限。



Disclaimer (免责声明)

1) Attention please 注意事项

The information describes the type of component should not be considered as assured characteristics. Terms of delivery and rights to change design reserved. Due to technical requirements components may contain dangerous substances.

该器件描述了组件的信息可能存在不确定性。因器件潜在的危险物质可能性，本公司保留对交付条款和设计更改的权利。

For information on the types in question please contact our Sales Organization.

如需咨询相关信息，请联系我们的销售组织。

2) Product and functional safety devices/applications or medical devices/applications 产品安全设备/应用或医疗设备/应用

The components are not developed, constructed or tested for the application as safety relevant component or for the application in medical devices.

该器件不适用于安全相关、医疗设备应用的开发、构建或测试用途。

Glossary (注解)

1) Brightness: Brightness values are measured during a current pulse of typically 20ms, with an internal reproducibility of $\pm 5\%$. 亮度

度: 亮度值通常在 20ms 电流脉冲期间测量，内部再现性为 $\pm 5\%$ 。

2) Chromaticity Coordinates: Chromaticity Coordinates are measured during a current pulse of typically 20ms, with an internal reproducibility of ± 0.003 . 色域坐标: 色域坐标值通常在 20ms 电流脉冲期间测量，内部再现性为 ± 0.003 。

色域坐标: 色域坐标值通常在 20ms 电流脉冲期间测量，内部再现性为 ± 0.003 。

3) Forward Voltage: The forward voltage is measured during a current pulse of typically 20ms, with an internal reproducibility of ± 0.05 V. 正向电压: 正向电压通常在 20ms 电流脉冲期间测量，内部再现性为 ± 0.05 V。

正向电压: 正向电压通常在 20ms 电流脉冲期间测量，内部再现性为 ± 0.05 V。

4) Reverse Operation: Continuous reverse operation is not allowed 反向操作: 不允许连续反向操作。

5) Typical Values: Due to the special conditions of the manufacturing processes of semiconductor devices, the typical data or calculated correlations of technical parameters can only reflect statistical figures. These do not necessarily correspond to the actual parameters of each single product, which could differ from the typical data and calculated correlations or the typical characteristic line. If requested, e.g. because of technical improvements, these typ. data will be changed without any further notice.

典型值: 由于半导体器件制造工艺的特殊条件，技术参数的典型数据或计算相关性只能反映统计数字。这些参数不一定对应每个产品的实际参数，可能不同于产品的典型数据和计算相关性或典型特性线。如有要求（例如由于技术改进），这些典型数据会被更改，恕不另行通知。

典型值: 由于半导体器件制造工艺的特殊条件，技术参数的典型数据或计算相关性只能反映统计数字。这些参数不一定对应每个产品的实际参数，可能不同于产品的典型数据和计算相关性或典型特性线。如有要求（例如由于技术改进），这些典型数据会被更改，恕不另行通知。

6) Characteristic curve: In the range where the line of the graph is broken, you must expect higher differences between single devices within one packing unit. 特性曲线: 如图形线段断开，即可预期同一封装单元内的单个器件之间的差异会较大。

特性曲线: 如图形线段断开，即可预期同一封装单元内的单个器件之间的差异会较大。



Revision History (版本号)

Revision record 修订记录		
Version 版本	Content of change 变更内容	Date record 日期
Version 1.0 1.0 版本	First Release. 发行第一版。	2024-03-08

Published by APT Electronic Co.,Ltd.
No.33,South of Huan Shi Road, Nansha
District, Guangzhou© All Rights Reserved.

EU RoHS and China RoHS compliant product

此产品符合欧盟 RoHS 指令的要求;



按照中国的相关法规和标准, 不含有毒物质或元素。